

NS300T

User Manual/Assembly Instructions



ERGOMAT

User manual – ErgoPerfect® NS300T height adjustable table

Congratulations! You are now the owner of the new **ErgoPerfect® NS300T** height adjustable table!

This new, modern, electrically-controlled, height adjustable table, is designed for use in office or industrial assembly environments. The table is intended for use as a height adjustable work station. The height adjustment function makes it possible to vary working posture, bringing ergonomic improvements to the workplace.

We recommend that you read the user manual carefully before using the table. Please note: Prohibitions, warnings and good advice on ergonomics! The user manual should be kept with the table!

How the table works

The height adjustment function works by means of an electric spindle motor. The spindle is activated by a control box, which is connected to a service panel. The control box has an overload protection device that ensures that the up/down function is cut off if the table is overloaded.

Instructions for use

The height adjustment function can only be activated from the control panel that is fitted to the underside of the table top. The panel has two buttons. The table will move as long as pressure is applied to one of the buttons.

The table has no on/off switch and can only be switched off at the mains contact.

Take care when adjusting table height (danger of crushing).

In case of malfunction or similar, see the Troubleshooting Guide in this manual.

Maintenance

The table is in principle maintenance-free. If necessary, all parts may be wiped with a slightly damp cloth and mild soapy water. Internal parts may not be cleaned. Never use cleaning products on electrical parts. Never spray/apply oil to the table lifting columns as this will damage the mechanism.

Assembly

The table should be assembled on a firm, plane floor. The table top can be levelled by adjusting the screws in the table feet. Reset the lifting columns by adjusting the table to its lowest position. (Reset by pushing both buttons simultaneously, after which the table adjusts to its lowest position.) Raise the table so that there is space enough underneath to install the cable tray.

The table is now ready for use.

Make sure that the table has been reset before fitting the cable tray. Please note: Always remove the cable tray before resetting the table.

Transport

Before moving the table, always adjust to its lowest position and disconnect electrical cables. Always remove the cable tray before resetting the table. Assembly procedures must be repeated once the table is at its new location.

For transportation and storage the table can be dismantled, i.e. table top separated from the table frame. Please remember to protect table frame and table top from scratches, etc. keep screws in a safe place!

Ergonomics

- Once the table is installed, check that it can easily be raised and lowered, that there are no hindrances to stepless movement over the entire range of movement.
- Remember: change working posture at regular intervals. Try raising or lowering the table just a couple of centimetres at regular intervals. Varying posture is key to minimising the risk of strain and injury.

- Vary sitting posture from a seated position with thighs horizontal to a higher seat height with a slanted chair seat, sloping thighs and open hip position.
- Recommendation: use a chair with a sliding seat angle, which encourages you to tip the chair, reducing the risk of developing a slipped disc.
- Remember: standing puts less strain on the back than sitting.

Prohibitions, warnings and good advice

Failure to comply with or observe all assembly, safety and operation instructions and warnings regarding the use of this height adjustable table may result in serious physical injury!

- The height adjustable table is not intended for lifting people.
- The height adjustable table may not be installed on a slant or in an otherwise unstable position. If the floor is not plane, the table can be levelled using the levelling screws on the table feet.
- Do not damage or crush the supply cable!
- The table is designed for maximum 2 minutes' continuous activation, or maximum 6 minutes activation per hour.
- Please note: Height adjustment function presents a danger of crushing! This applies in particular to the area under the table (cross-bar and any furniture on castors) and the immediate area around the table top (e.g. shelving, window sills and neighbouring tables).
- The entire table top must be free standing, at least 25 mm from shelving, window sills, other tables and obstructions.
- Check that cables of connected products are long enough. Carefully adjust the table to highest and lowest positions.
- To reduce electricity consumption, switch off at the mains (e.g. at night).

Repairs

Repairs should be carried out by an authorised technician. None of the table parts may be repaired by the consumer!
For repairs: Please contact Ergomat A/S.

Warranty

All products in the ErgoPerfect® NS-table series are guaranteed 2-years against defects in manufacture and materials that are a result of the normal use of the height adjustable table. The right of return does not apply in the case of defects, damage, or wear and tear that is either directly or indirectly caused by incorrect assembly, incorrect use or other actions that are not described in the user manual.

Disposal

The table must be disposed of as follows:

- Table top must be sent for incineration.
- The metal table frame must be deposited as recyclable metal.
- Electronic parts must be deposited as electrical scrap.

Technical specifications

Dimensions:	137 x 74 x 70 cm
Weight:	37 kg (without table top)
Electrical connection:	230 V 50 Hz
Output consumption:	At max. load 400 watts
Electrical consumption (standby):	2 watts
Load:	Maximum lifting capacity 300 kg, evenly distributed on table top and table frame.
Height range:	70 - 119 cm.
Speed:	Max. 43 mm per second, not loaded
Operation:	Connected to mains supply 230 V 50 Hz. The table may be activated maximum 2 minutes continuously over an 18 minute period.

Troubleshooting Guide for height-adjustable table

The table does not work:

- Check the mains plug – is it switched on?
- Check the supply cable: is it connected to the control box?
- Check the control box: are the cables connected?
- Check the control panel: are the cables connected?
- Check that all cables are firmly connected.
- Check cables: are they cut or disconnected?
- Check mains fuses: are they serviceable?
- Contact Ergomat A/S for service

The table height adjustment function is out of control:

- Cut supply to mains plug or remove the mains plug from the socket. Reconnect power. If there is still a problem, contact Ergomat A/S.

The table moves at an angle.

- Reset the table (Please remember to remove cable tray first)

The table is no longer at level:

- Check the adjustable levelling screws on table feet. If the screws are OK, reset the table (Please remember to remove cable tray first).

The table makes an unusual noise.

- Check that the table is not scraping up against other tables/obstructions.
- Listen to detect whether the sound is coming from the table lifting columns or from the control box. If the sound comes from the lifting columns or the control box, disconnect electricity supply. Please contact Ergomat A/S. Do not attempt height adjustment until the table has been serviced!

Declaration of conformity

We declare that the ErgoPerfect® NS height adjustable table conforms to the following directives and other normally applicable documents:

- European Council Directives 98/37/EF
- European Council Directives 89/336/EØF (“the EMC Directive”) and subsequent amendments
- European Council Directives 73/23/ and subsequent amendments

With reference to the “Machinery Directive” (98/37/EF) we are obliged to state that:

- The height adjustable table is regarded as machinery.
- The height adjustable table must not be put into use unless it is fitted and installed in accordance with the instructions of this user manual.

Local agent contact information: Tel: +45 7022 1840 or email: info@ergomat.dk.

Ergomat A/S hopes you have a good day at work!

ErgoPerfect®

ERGOMAT

Sunekær 13-15, DK-5471 Sønderød, Denmark, www.ergomat.com

Packing list

Pack A:

- 1 # frame
- 1 # cross bar
- 2 # table feet

Pack B:

- 2 # table lifting columns
- 12 # insex screw Ø6x16
- 8 # insex screws Ø6x25
- 6 # adjustable screws
- 24 # chipboard screws Ø4x20
- 6 # top nuts Ø10
- 4 # steel set screws Ø8x14
- 2 # motor cables
- 1 # mains cable
- 1 # control panel
- 1 # control box

Pack C:

- 1 # cable tray
- 2 # clips
- 6 # chipboard screws Ø4x20

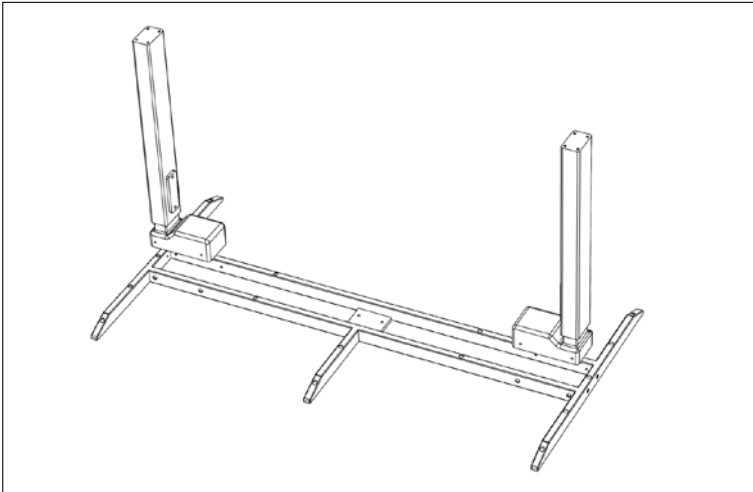

1

Attach the table legs to the frame by loosely screwing in all screws, before tightening (see picture 3).

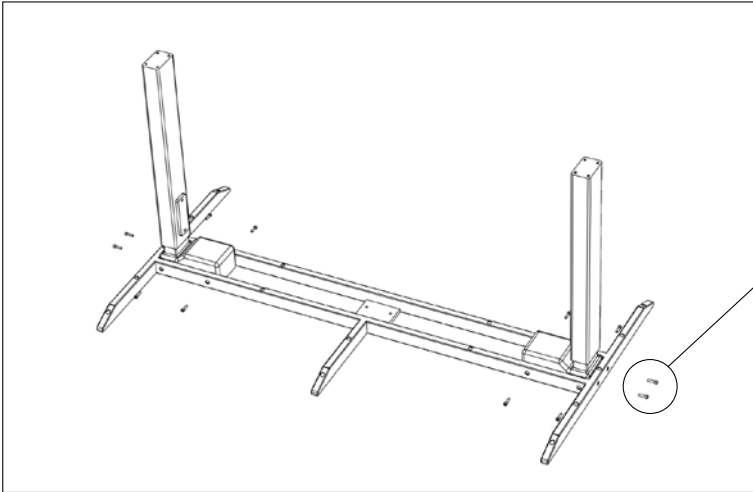

2

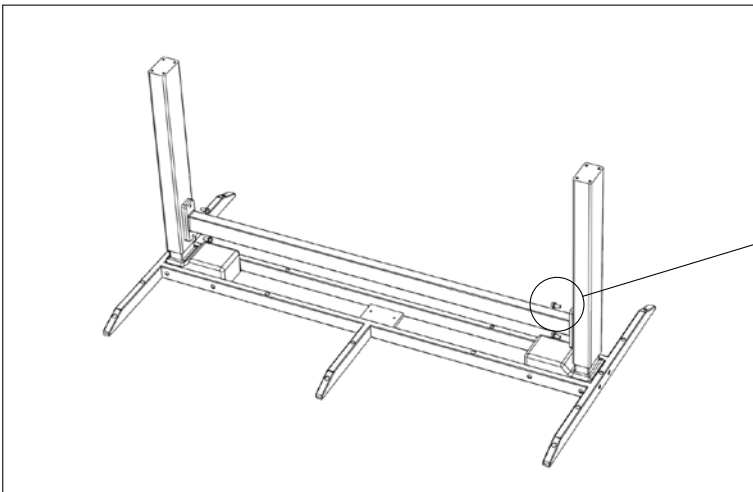
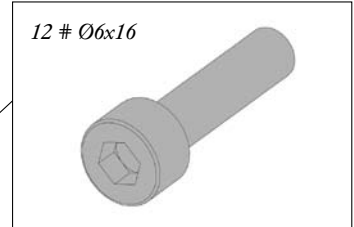

3

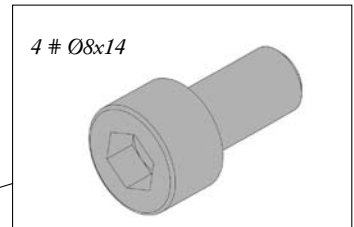

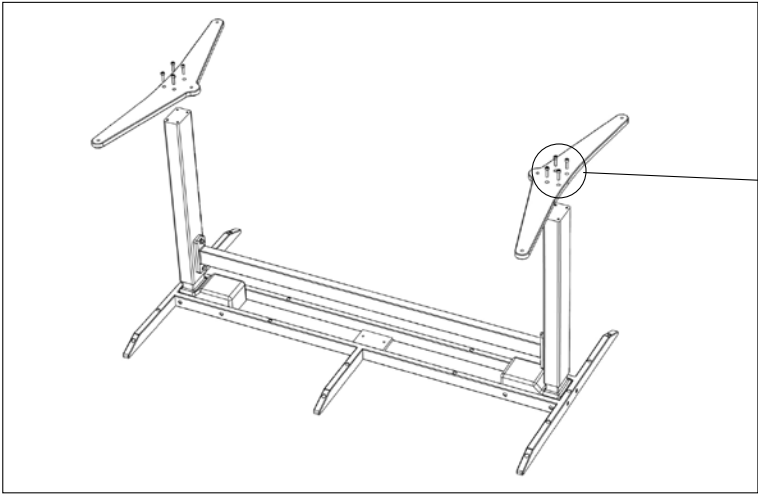

4

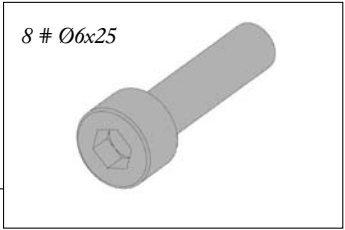

8 # Ø6x25

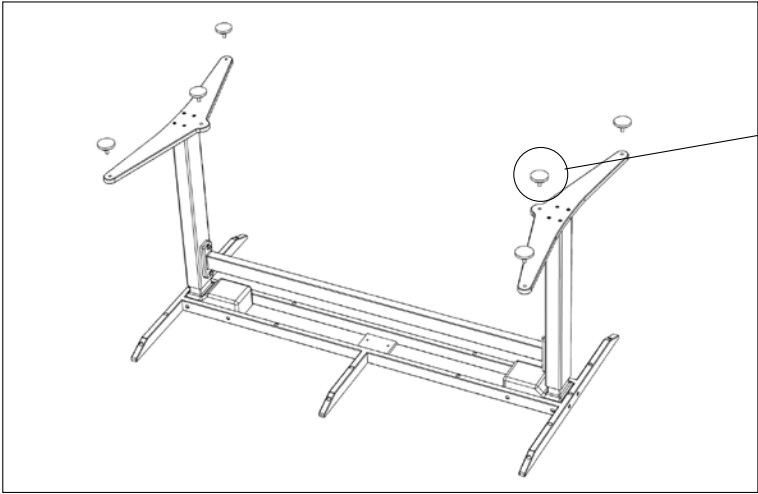

5

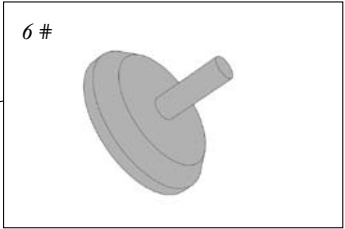

6 #

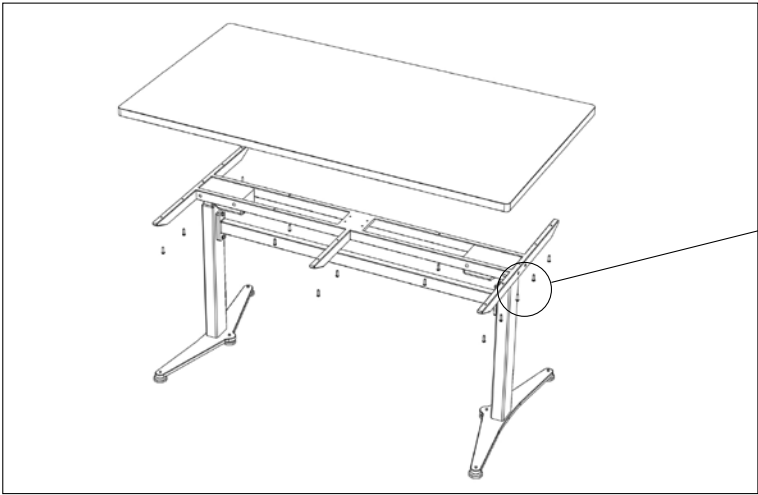

6

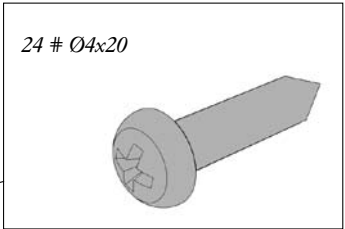

24 # Ø4x20

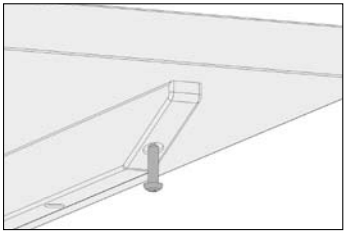

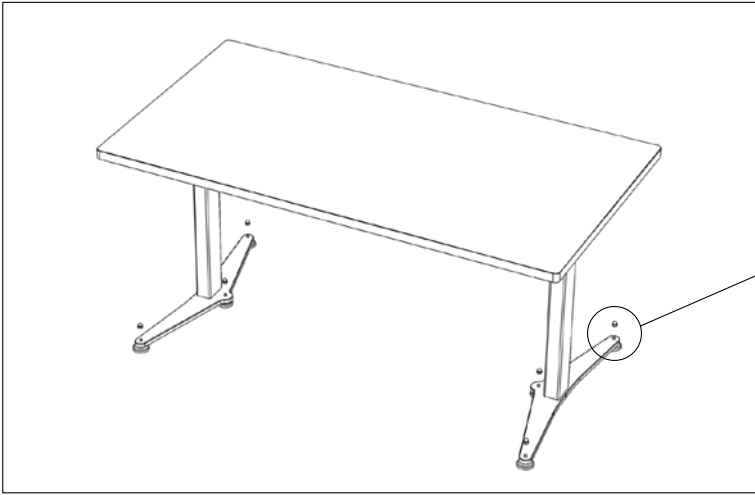

7

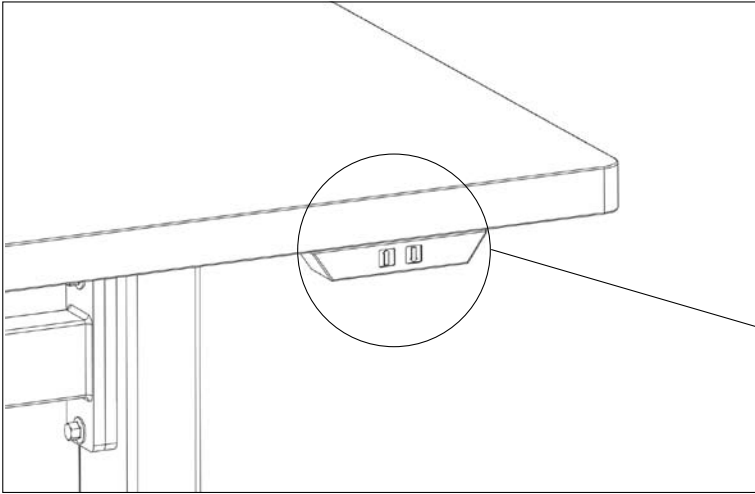
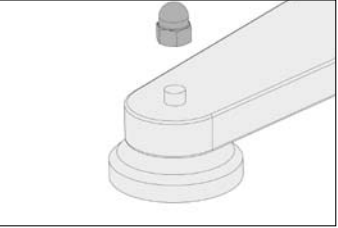
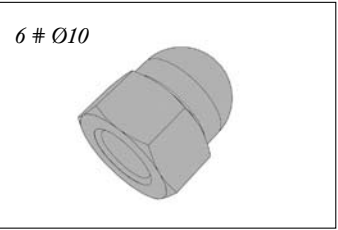

8

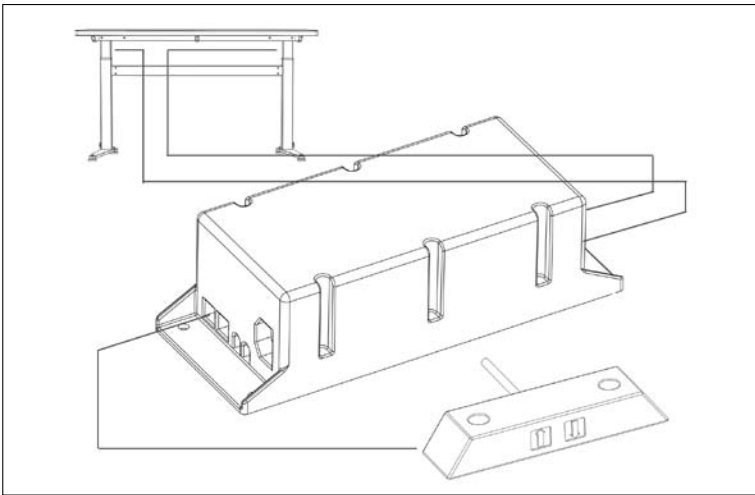
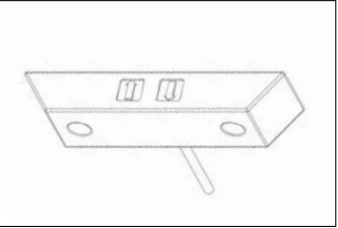
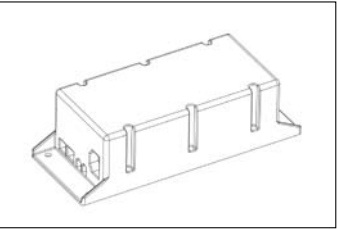

9

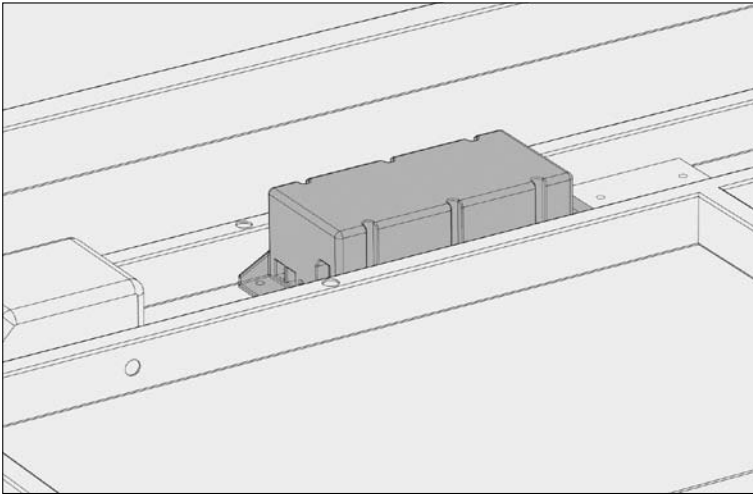

10

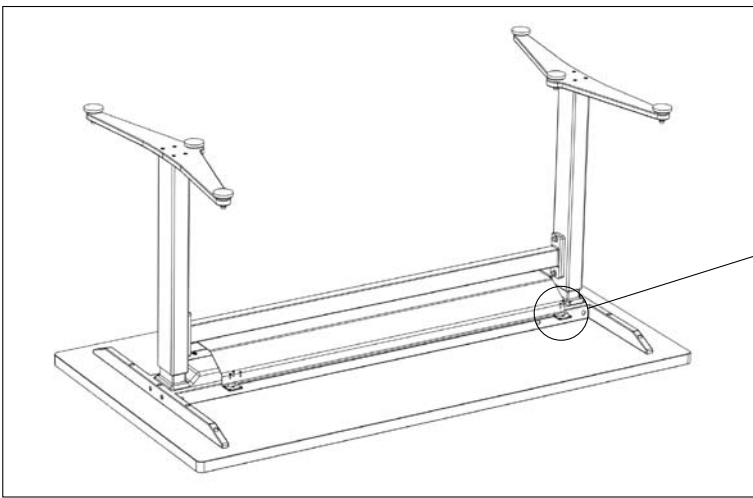

11

6 # Ø4x20

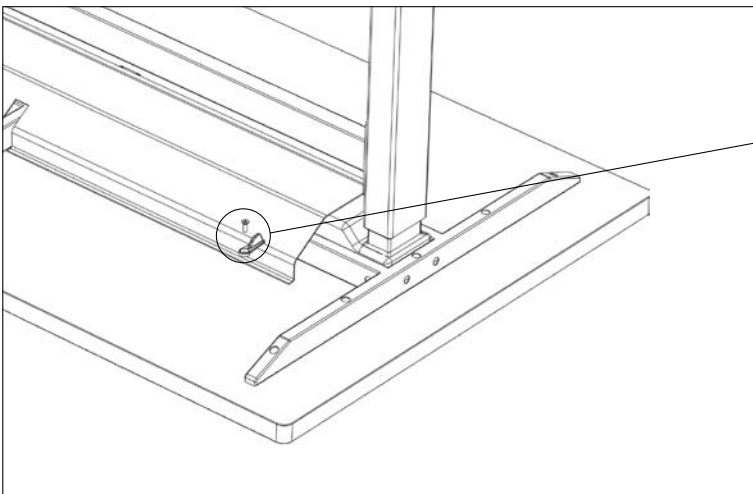
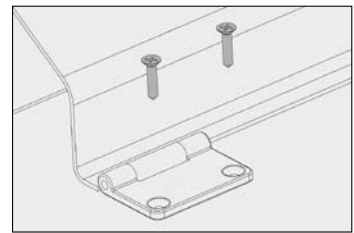

12

2 # clips

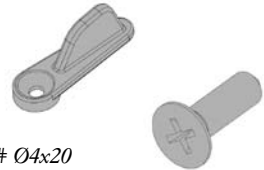

2 # Ø4x20

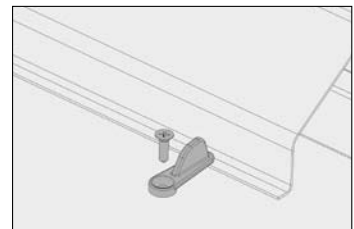

Ergomat A/S
Sunekær 13-15
DK-5471 Sønderlø
Tel. +45 70 22 18 40
Fax +45 70 23 18 40
info@ergomat.dk
www.ergomat.com

ERGOMAT
www.ergomat.com